

> 产品特点

结构紧凑，安装方便

高性价比

适用于各类通用电子设备及测量仪器



> 技术指标

额定电压	250AC
额定电流	0.5-200A
工作频率	50/60Hz
耐电压测试	相-相 1700VDC
	相-地 2000VAC

> 产品列表

产品型号	连接方式	额定电流	漏电流	放电电阻	电路图原理图	外形尺寸	重量 (g)
ZJ2A-1	引线	1	<0.5mA	/	fig.1	fig.1	65
ZJ2A-3	引线	3	<0.5mA	/	fig.1	fig.1	65
ZJ2A-6	引线	6	<0.5mA	/	fig.1	fig.1	65
ZJ2A-10	焊片/螺栓	10	<0.5mA	/	fig.1	fig.2	75
ZJ2AC-6	焊片/螺栓	6	<1mA	1.5MΩ	fig.2	fig.3/fig.4	140
ZJ2AC-10	焊片/螺栓	10	<1mA	1.5MΩ	fig.2	fig.3/fig.4	170
ZJ2AC-20	焊片/螺栓	20	<1mA	1.5MΩ	fig.2	fig.3/fig.4	170
ZJ2AC-30	M6螺栓	30	<1mA	1.5MΩ	fig.2	fig.5	320
ZJ2AC-50	M6螺栓	50	<2mA	1.5MΩ	fig.2	fig.6	600
ZJ2AC-100	M8螺栓	100	<2mA	1.5MΩ	fig.2	fig.7	1380
ZJ2AC-150	M10螺栓	150	<2mA	1.5MΩ	fig.2	fig.8	1900
ZJ2AC-200	M10螺栓	200	<2mA	1.5MΩ	fig.2	fig.8	1920

> 电路原理图

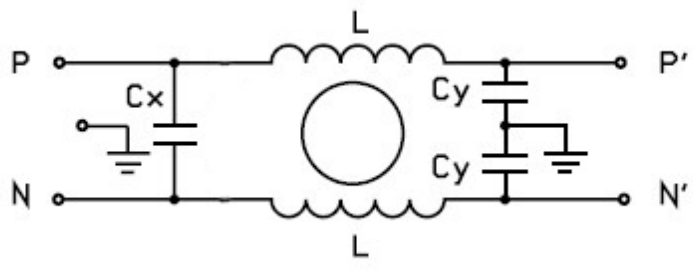

fig. 1

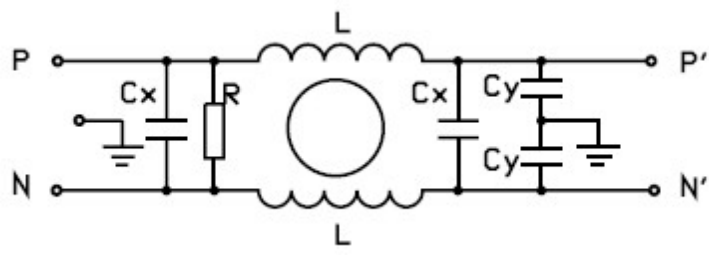

fig. 2

> 外形尺寸图

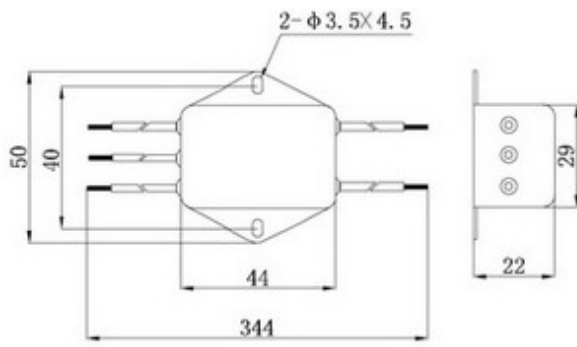
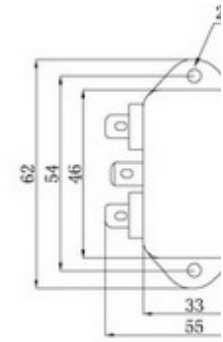

Fig. 1



F

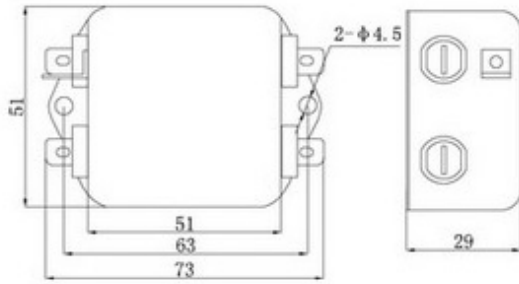
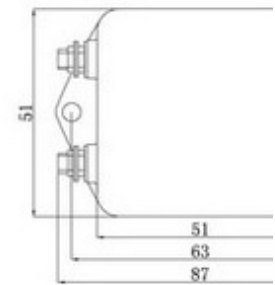

Fig. 3



F

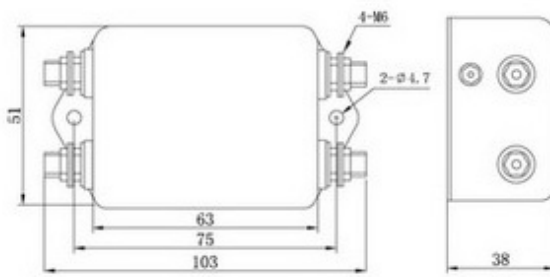
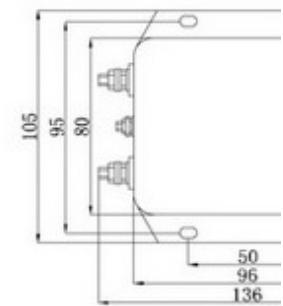

Fig. 5



F

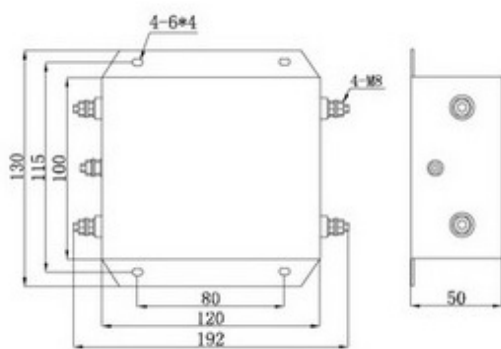
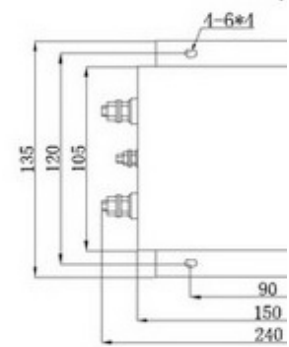

Fig. 7



F

> 插入损耗图

— 共模 ---- 差模

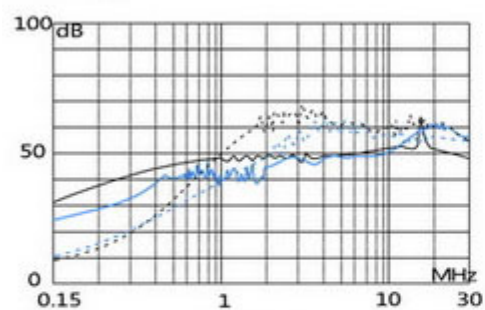

ZJ2A-1 ZJ2A-3

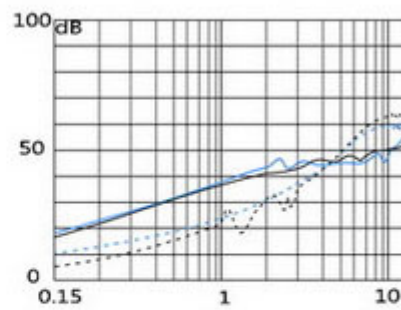

ZJ2A-6 ZJ2A-1

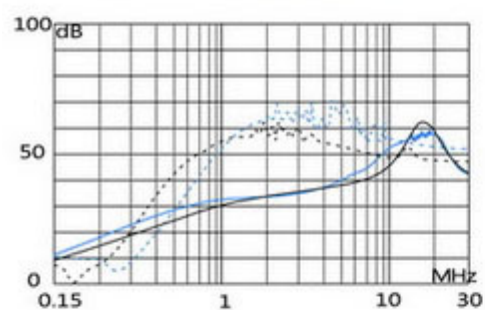

ZJ2AC-6 ZJ2AC-10

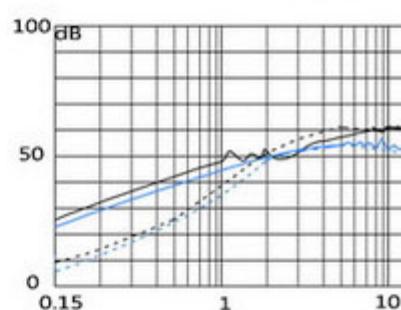

ZJ2AC-20 ZJ2AC-

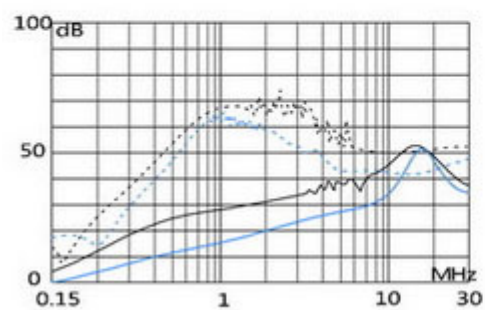

ZJ2AC-50 ZJ2AC-100

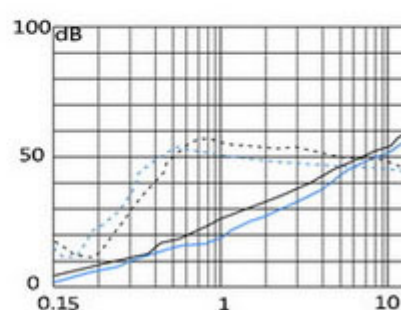

ZJ2AC-150 ZJ2AC-