

TO-92 Plastic-Encapsulate Voltage Regulators

CJ78L08 Three-terminal positive voltage regulator

FEATURES

- Maximum output current
I_{OM}: 0.1A
- Output voltage
V_O: 8V
- Continuous total dissipation
P_D: 0.625 W (T_a= 25 °C)

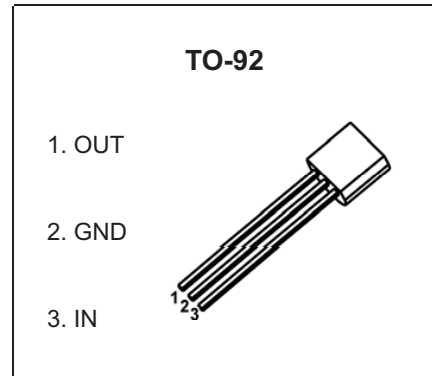

MARKING

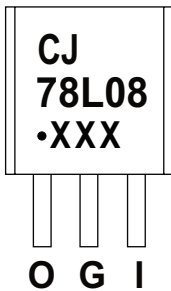

CJ78L08=Device code
 Solid dot=Green molding compound device,
 if none,the normal device
 XXX=Code

ORDERING INFORMATION

Part Number	Package	Packing Method	Pack Quantity
CJ78L08	TO-92	Bulk	1000pcs/Bag
CJ78L08-TA	TO-92	Tape	2000pcs/Box

ABSOLUTE MAXIMUM RATINGS (Operating temperature range applies unless otherwise specified)

Parameter	Symbol	Value	Unit
Input Voltage	V _i	30	V
Thermal Resistance from Junction to Ambient	R _{θJA}	160	°C/W
Operating Junction Temperature Range	T _{OPR}	-25~+125	°C
Storage Temperature Range	T _{STG}	-65~+150	°C

ELECTRICAL CHARACTERISTICS

$T_a=25^\circ\text{C}$ unless otherwise specified ($V_i=14\text{V}$, $I_o=40\text{mA}$, $C_i=0.33\mu\text{F}$, $C_o=0.1\mu\text{F}$, unless otherwise specified)

Parameter	Symbol	Test conditions	Min	Typ	Max	Unit	
Output voltage	V_o	25°C	7.7	8.0	8.3	V	
		0-125 $^\circ\text{C}$	$10.5\text{V}\leq V_i\leq 23\text{V}$, $I_o=1\text{mA}\sim 40\text{mA}$	7.6	8.0	8.4	V
			$I_o=1\text{mA}\sim 70\text{mA}$	7.6	8.0	8.4	V
Load Regulation	ΔV_o	$I_o=1\text{mA}\sim 100\text{mA}$	25°C	18	80	mV	
		$I_o=1\text{mA}\sim 40\text{mA}$	25°C	10	40	mV	
Line regulation	ΔV_o	$10.5\text{V}\leq V_i\leq 23\text{V}$	25°C	42	175	mV	
		$11\text{V}\leq V_i\leq 23\text{V}$	25°C	36	125	mV	
Quiescent Current	I_q	25°C		4	6	mA	
Quiescent Current Change	ΔI_q	$11\text{V}\leq V_i\leq 23\text{V}$	0-125 $^\circ\text{C}$		1.5	mA	
	ΔI_q	$1\text{mA}\leq I_o\leq 40\text{mA}$	0-125 $^\circ\text{C}$		0.1	mA	
Output Noise Voltage	V_N	$10\text{Hz}\leq f\leq 100\text{KHz}$	25°C	54		$\mu\text{V}/V_o$	
Ripple Rejection	RR	$13\text{V}\leq V_i\leq 23\text{V}$, $f=120\text{Hz}$	0-125 $^\circ\text{C}$	37	46	dB	
Dropout Voltage	V_d	25°C		1.7		V	

* Pulse test.

TYPICAL APPLICATION

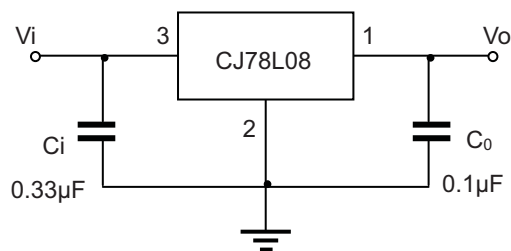

Note: Bypass capacitors are recommended for optimum stability and transient response and should be located as close as possible to the regulators.

Typical Characteristics

Output Characteristics

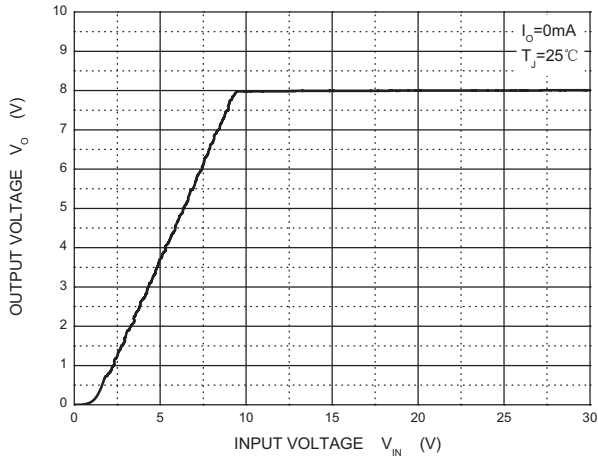

Dropout Characteristics

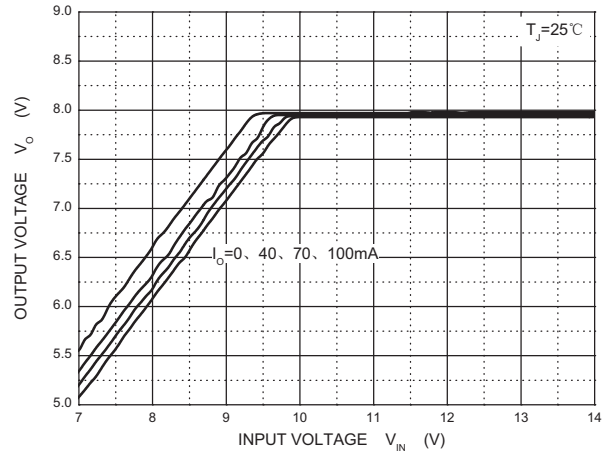

Quiescent Current vs Input Voltage

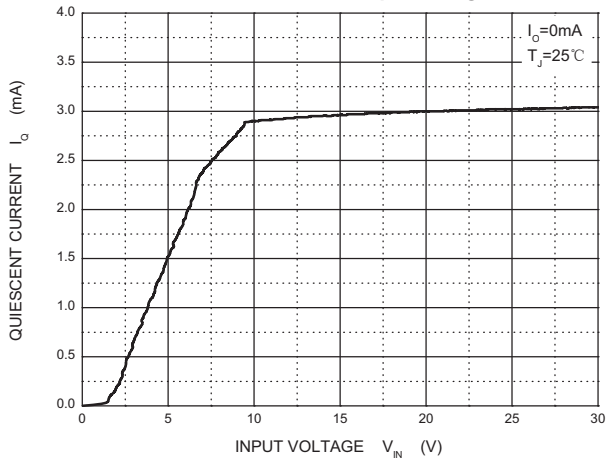

Current Cut-off Grid Voltage

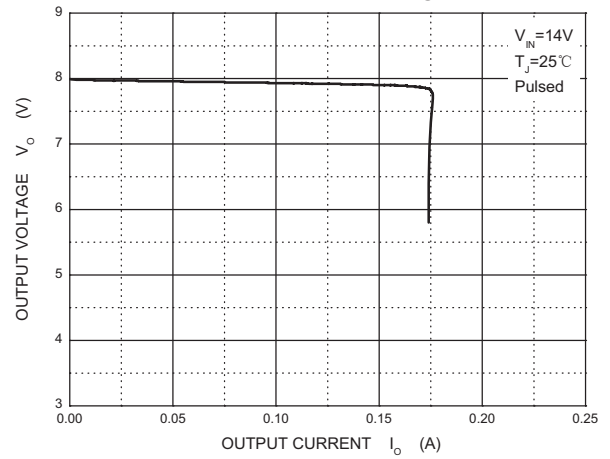

Output Voltage vs Junction Temperature

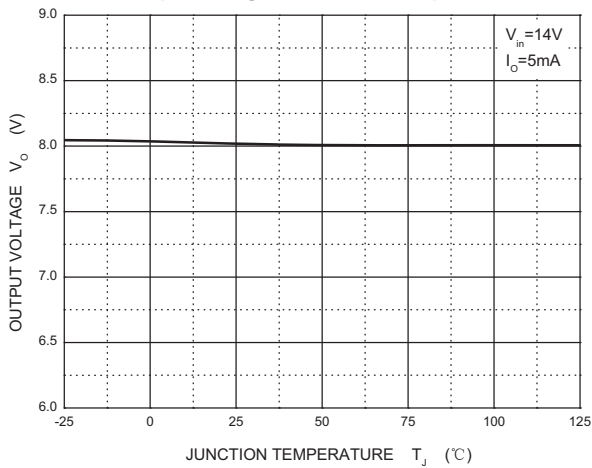

Power Derating Curve

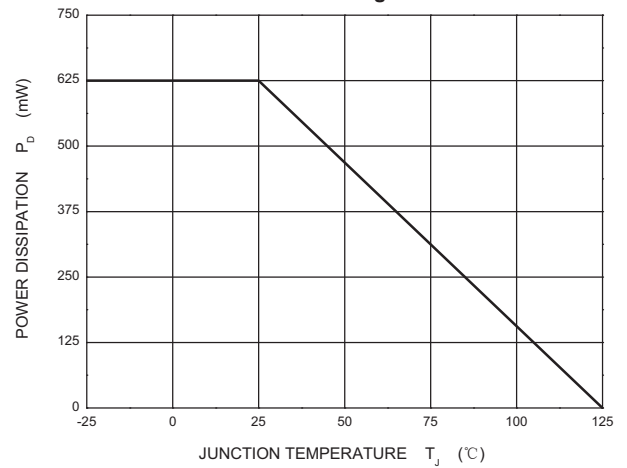

TO-92 Package Outline Dimensions

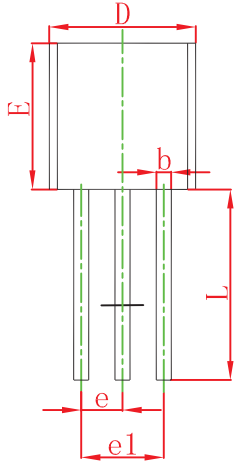
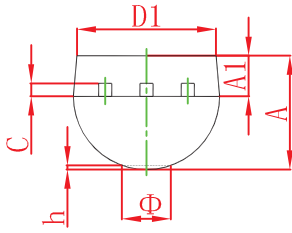

Symbol	Dimensions In Millimeters		Dimensions In Inches	
	Min	Max	Min	Max
A	3.300	3.700	0.130	0.146
A1	1.100	1.400	0.043	0.055
b	0.380	0.550	0.015	0.022
c	0.360	0.510	0.014	0.020
D	4.300	4.700	0.169	0.185
D1	3.430		0.135	
E	4.300	4.700	0.169	0.185
e	1.270 TYP		0.050 TYP	
e1	2.440	2.640	0.096	0.104
L	14.100	14.500	0.555	0.571
Φ		1.600		0.063
h	0.000	0.380	0.000	0.015

TO-92 Suggested Pad Layout

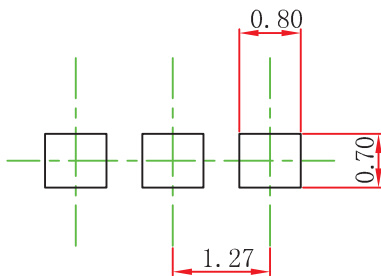

Note:

1. Controlling dimension: in millimeters.
2. General tolerance: $\pm 0.05\text{mm}$.
3. The pad layout is for reference purposes only.

NOTICE

JCET reserve the right to make modifications, enhancements, improvements, corrections or other changes without further notice to any product herein. JCET does not assume any liability arising out of the application or use of any product described herein.

TO-92 PACKAGE TAPEING DIMENSION

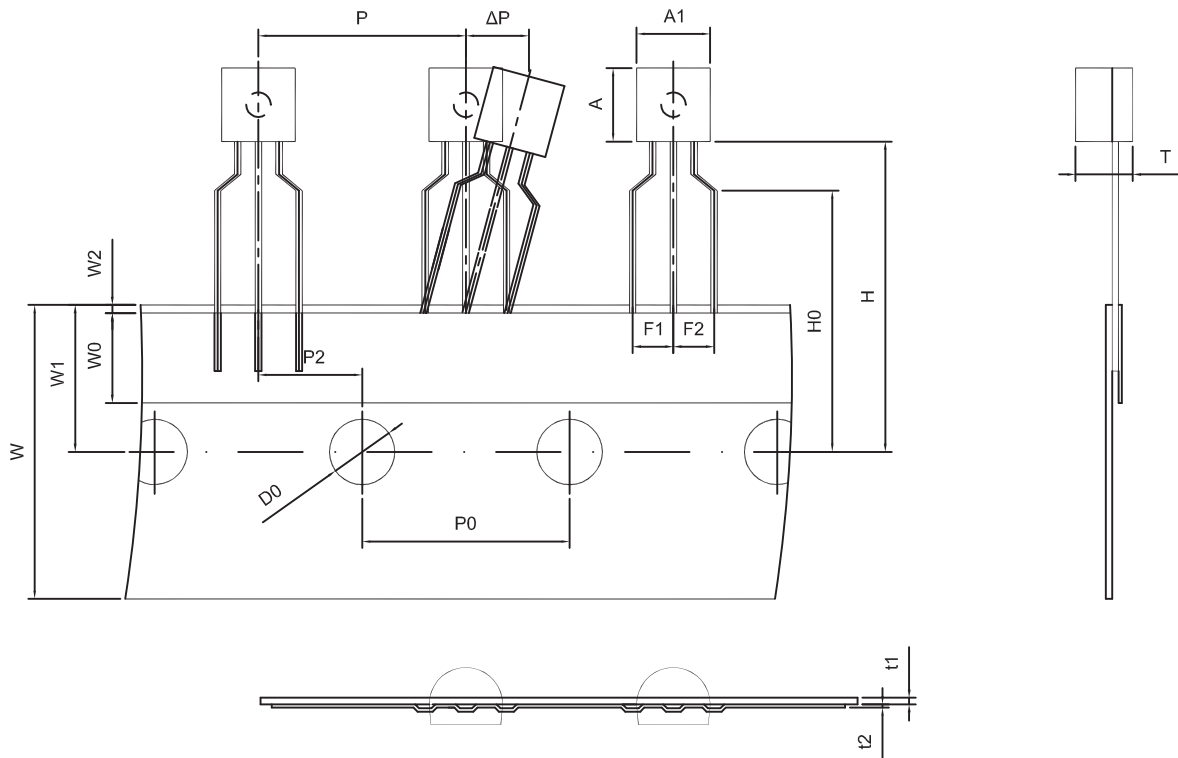

Dimiensions are in millimeter								
A1	A	T	P	P0	P2	F1	F2	W
4.5	4.5	3.5	12.7	12.7	6.35	2.5	2.5	18.0
W0	W1	W2	H	H0	D0	t1	t2	ΔP
6.0	9.0	1.0 MAX.	19.0	16.0	4.0	0.4	0.2	0

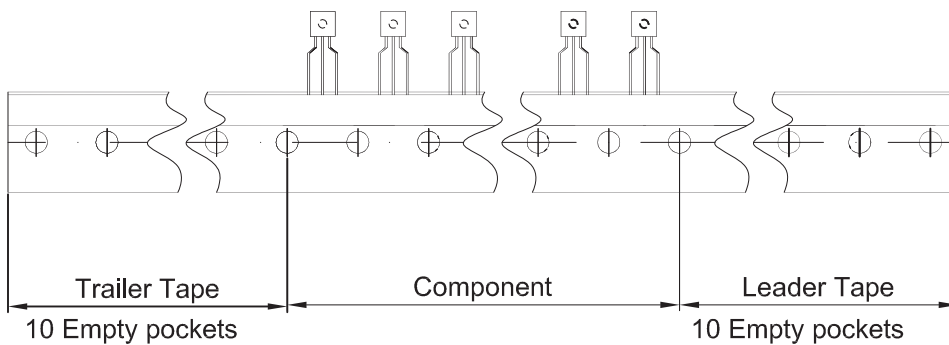

Package	Box	Box Size(mm)	Carton	Carton Size(mm)
TO-92	2000 pcs	333×162×43	20,000 pcs	350×340×250